

# INSTRUCTION MANUAL



**Q4 FPV** NO: H111D



---

# INDEX

IMPORTANT SAFETY NOTES	04	7.START TO FLY	10
<b>SYMBOL EXPLANATION</b>	04	7.1 Normal Mode / Expert Mode	10
<b>USAGE ADVICE</b>	04	7.2 Headless Mode	11
<b>LIPO BATTERY SAFETY NOTES</b>	04	7.3 Aerial Flip	11
INDEX	04	8.TRANSMITTER	13
INTRODUCTION	05	8.1 Input Key Function	14
1 ITEMS INCLUDED IN THE BOX	05	8.2 Install the TX Battery	15
2 QUAD COPTER	06	8.3 Video Replay Setup	15
3 MOTOR LED INDICATOR	06	8.4 Time Setup	16
4. QUAD COPTER BATTERY	06	8.5 Format SD Card Setup	16
4.1 Introduction	06	8.6 Reversing Channel Setup	17
4.2 Charging	07	8.7 Sensitivity Setup	17
5.PROPELLERS	07	8.8 Frequency Selectable 5.8Ghz	18
6.START TO FLY	08	9.CALIBRATION	18
6.1 Flight Environment	08	<b>EXPLODED VIEW</b>	19
6.2 Binding	08	<b>H111D SPARE PART CHART</b>	20
6.3 Basic Flight	09	<b>H111D TROUBLE SHOOTING</b>	21
6.4 Video	10	<b>FCC INFORMATION</b>	22

---

Please read the instruction manual carefully!

## IMPORTANT SAFETY NOTES

### OPERATION:

Be extremely careful and responsible when using the drone. Small electronic components can be damaged by crashing or by dropping the Q4 into water. To avoid further damages, please replace broken parts immediately.

### Flight:





- Take responsibility for the safety of yourself and others when flying the Q4!
- Do not fly the Q4 in crowded places.
- Do not fly in bad weather.
- Never try to catch the Q4 while it is in flight.
- This model is intended for experienced pilots age 14+.
- Power off the Q4 after flight, to prevent the propellers from causing injuries.
- Always remove the battery after you stop flying to avoid injuries from accidentally powering on the motors.
- Always take great caution to protect yourself when near the propellers.  
The flight system will start after powering on regardless of the transmitter signal. The high speed propellers are very dangerous.
- Power off the Q4 after every flight or the propellers may still rotate and cause injury.

# INTRODUCTION

Thank you for buying HUBSAN products. The Q4 nano quad is designed as an easy-to-use, full-featured RC model capable of hovering and acrobatic flight maneuvers. Please read the manual carefully and follow all the instructions. Be sure to keep the manual for future reference.

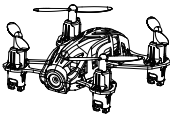
## 1 ITEMS INCLUDED IN THE BOX

Check all the items in the box before using.

S/N	Part Name	Photos	Qty	Remarks
1	Quad copter		1PC	Equipped with one Li-Po Battery
2	Proppellers		8PCS	Propeller A 4pcs Propeller B 4pcs
3	Transmitter		1PC	FPV Transmitter (Powered by 4pcs of AA batteries- Not included)
4	USB Charger		1PC	For Li-Po battery charging
5	User Manual		2PCS	Disclaimer Hubsan Q4 Instruction Manual

## 2 QUADCOPTER

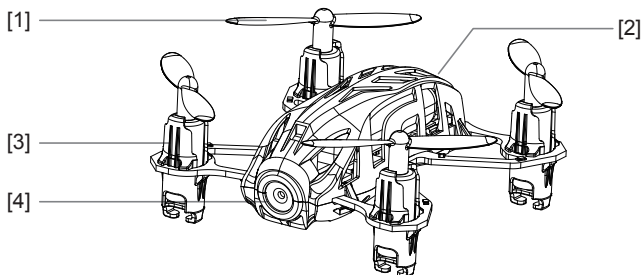

[1] Propellers

[2] Charging Plug

[3] Motor

[4] Camera

## 3. MOTOR LED INDICATOR

Indicator Status:

Front LED: is blue; Back LED: is red

Power on:

- 1) Before binding, 2 front LED indicators blink alternately, 2 back LED remain lighted
- 2) After binding, 4 LED indicators remain lighted

Headless Flight: 2 front LED blink slowly, 2 back LED remain lighted

Video: 2 front LED remain lighted, 2 back LED blink alternately

Low Power: 2 front LED remain lighted, 2 back LED blink quickly

## 4 QUAD COPTER BATTERY

### 4.1 INTRODUCTION

The quad copter battery is a rechargeable Li-Po battery with 180mAh capacity and 3.7V voltage. The battery should only be charged with the HUBSAN charger to avoid overcharge.

⚠ Please make sure the battery is fully charged before first time use.

## 4.2 CHARGING

Connect the battery to the USB charger, then connect the USB charger to USB devices, such as a computer or mobile power charger.

It takes around 30 minutes to fully charge the battery. The USB LED indicator is in red when charging and will light off when the battery is fully charged. Please unplug the charger and battery when the charging is completed.

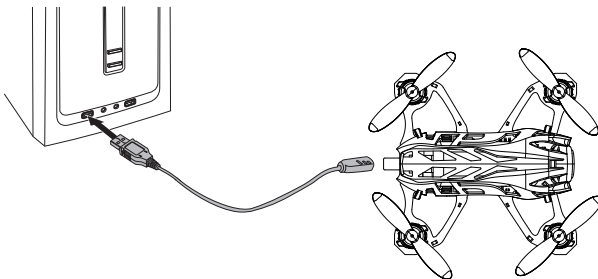

Please fully charge the batteries to avoid loss of control due to low voltage.

Risk of explosion if battery is replaced by an incorrect type.

Dispose of used batteries according to the local regulations.

## 5. PROPELLERS

Attach the propellers to the corresponding motors that are marked A and B, tighten the propellers and keep the motors deadlocked.

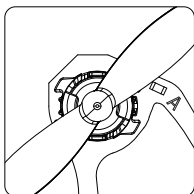

A=A

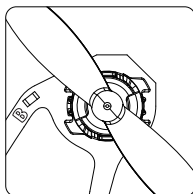

B=B

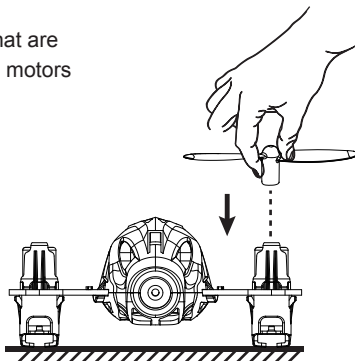

Disassemble the propellers with U wrench.

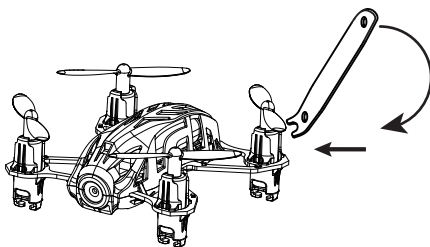

- ⚠️ • Make sure that the A and B propellers are installed correctly. The Q4 will not fly if propellers are improperly installed.
- Hazardous moving parts keep fingers and other body part away.

## 6. START TO FLY

### 6.1 FLIGHT ENVIRONMENT

- (1) The flying area should be open and without tall buildings or other obstacles; the steel structure within buildings interferes with the compass and the GPS signal.
- (2) DO NOT fly in bad weather such as strong wind, heavy snow, rain or fog.
- (3) Keep away from barriers, people, power cables, trees, and other obstructions.
- (4) Do NOT fly near radio towers or airports.
- (5) The Q4 control system will not work properly at the South or North Pole.
- (6) DO NOT fly in restricted areas and obey your country's laws and regulations.



*High Tension Line*



*Airport*



*Interference*

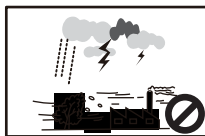

*Rain*

### 6.2 BINDING

Power on the transmitter until “Bind to Plane” displayed, then power on the drone, and place it very close to the transmitter, the binding will be completed after one “beep” heard.

Should the binding failed, please power off the drone and repeat above steps.



## 6.3 BASIC FLIGHT

The operation mode for the transmitter including Mode 1 or Mode 2. The manual will use Mode 2 as an example to illustrate the transmitter's operation.

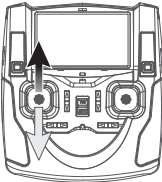
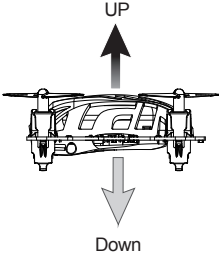
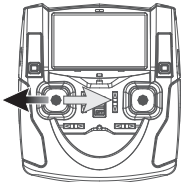
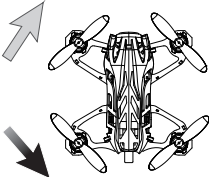
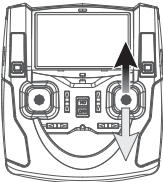
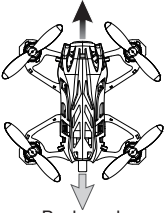
Transmitter (Model 2)	Q4	Remarks
	<p style="text-align: center;">UP</p>  <p style="text-align: center;">Down</p>	<p>The throttle stick controls the ascent and descent .</p> <p>Push up the stick and the Q4 will ascend.</p> <p>Pull down the stick and the Q4 will descend.</p> <p>When the stick is in the center, the Q4 will hover and hold its altitude automatically .</p> <p>Move the throttle stick above the center position to take off. (Move the stick gradually to prevent the Q4 from ascending too quickly.)</p>
	<p style="text-align: center;">Right rotation</p>  <p style="text-align: center;">Left rotation</p>	<p>The Rudder stick controls the rotate direction</p> <p>Push the stick to the left and the Q4 will rotate counter-clockwise</p> <p>Push the stick to the right and the Q4 will rotate clockwise.</p> <p>When the stick is in the center, the Q4 will keep the current direction and not rotate.</p> <p>Pushing harder will cause the Q4 to rotate faster in the corresponding directions.</p>
	<p style="text-align: center;">Forward</p>  <p style="text-align: center;">Backward</p>	<p>The Elevator stick moves the Q4 forward and backward.</p> <p>Push the stick up the and the Q4 will fly forward.</p> <p>Pull the stick down and the Q4 will fly backward.</p> <p>When the stick is in the center, the Q4 will hold its position.</p> <p>The angle of stick movement corresponds to the angle of tilt and flight speed.</p>

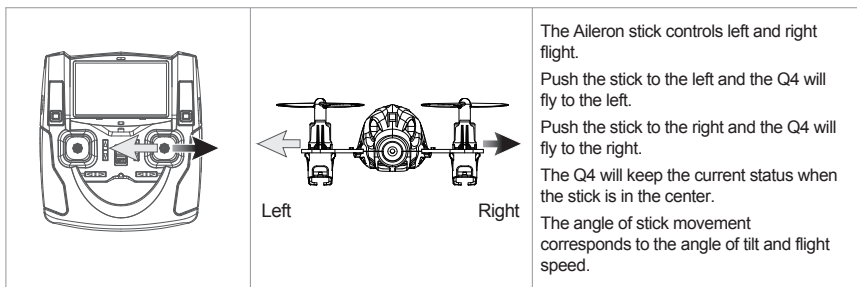

## 6.4 VIDEO

Insert the SD card into the transmitter before using Video function.

Press the Video button for 0.5 second to take videos and press again to save the videos.

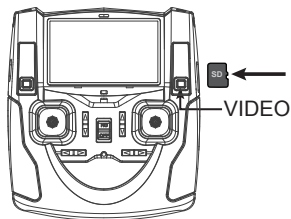

 Stop recording before the SD card is removed.

## 7. ADVANCED PERFORMANCE SETUP

### 7.1 NORMAL MODE/ EXPERT MODE

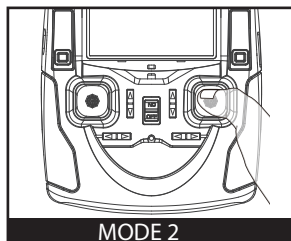
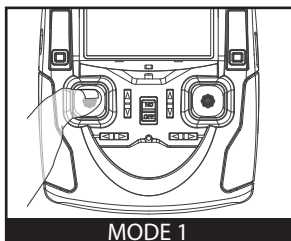

The default setting for Q4 is Normal Mode, and the Expert Mode can be activated to have a better sensitivity on the performance of the Q4.

Press the Elevator stick 0.5 second to shift between Normal Mode and Expert Mode.

When it enters into Expert Mode, "EXPERT MODE" will be displayed on LCD, indicated by two "Beeps".

## 7.2 HEADLESS MODE

Press the Throttle stick 0.5 second to switch on/ off headless mode.

Press the stick to enter into the headless Mode, indicated by two "beeps" and the front LED will blink slowly .

Press the stick again to exit headless Mode, indicated by one "beep".

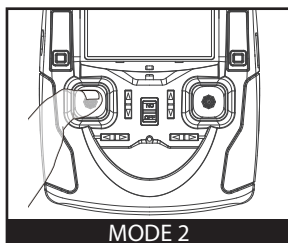
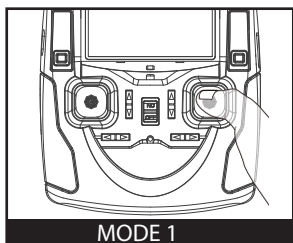

## 7.3 AERIAL FLIP

Press and hold down the Throttle stick for 1.5 seconds to enter Flip Mode, indicated by "beeps".

The beeps will last for 2 seconds. In this 2 seconds, push the accordance sticks to perform the flips.

### 7.3.1 Left Flip

Push the Aileron stick to the left. Release the stick to the center position after the flip.

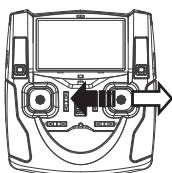

MODE 2

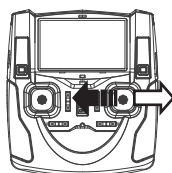

MODE 1

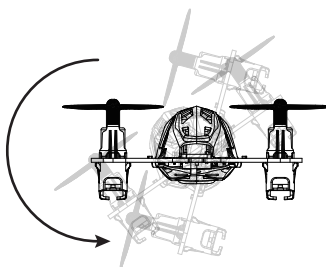

### 7.3.2 Right Flip

Push the Aileron stick to the right. Release the stick to the center after the flip.

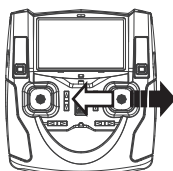

MODE 2

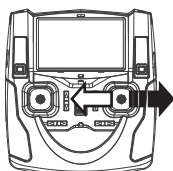

MODE 1

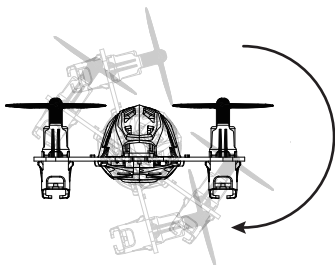

### 7.3.3 Forward Flip

Pull the Elevator stick forward. Release the stick to the center after the flip.



MODE 2



MODE 1

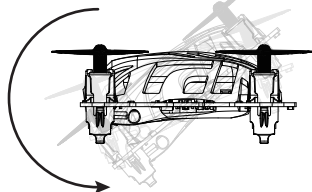

### 7.3.4 Backward Flip

Push the Elevator stick backward. Release the stick to the center after the flip.

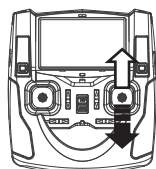

MODE 2

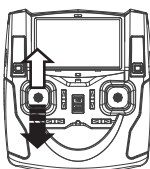

MODE 1

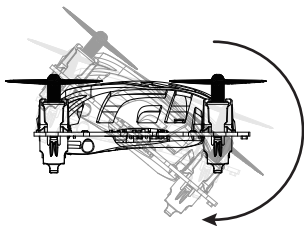

## 8. TRANSMITTER

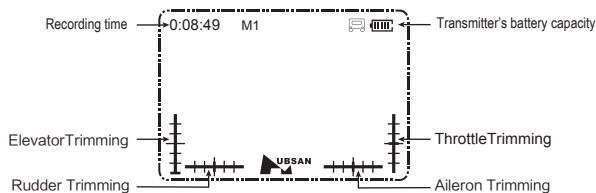

**MODE 1**

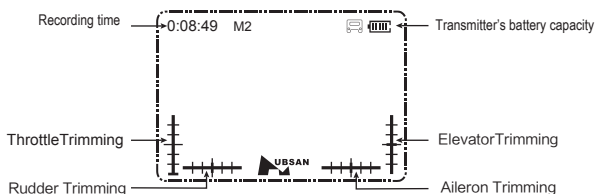

**MODE 2**

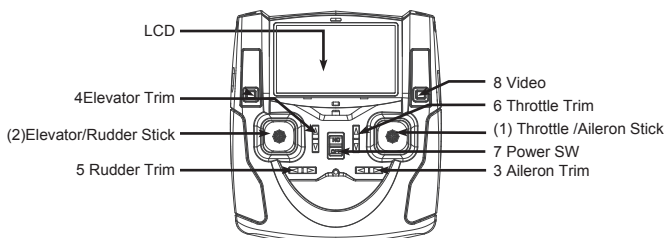

**MODE 1**

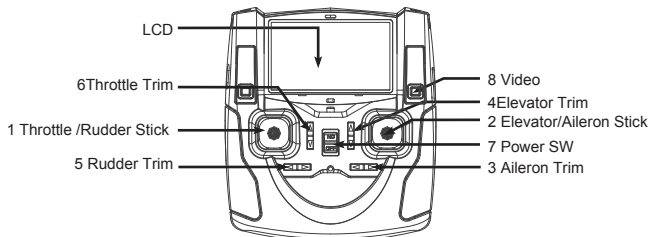

**MODE 2**

## 8.1 INPUT KEY FUNCTION

S/N	Mode/ Control	Function
(1)	<b>MODE 1</b> Throttle/Aileron Stick	Push the stick forward or backward and the quadcopter will ascend or descend; Push the stick left or right and the quadcopter will fly left or right.
(2)	<b>MODE 1</b> Elevator/Rudder Stick	Push the stick forward or backward and the quadcopter will fly forward or backward; Push the stick left or right and the quadcopter will rotate counter clockwise or clockwise.
1	<b>MODE 2</b> Throttle/ Rudder Stick	Push the stick forward or backward and the quadcopter will ascend or descend; Push the stick left or right and the quadcopter will rotate counter clockwise or clockwise.
2	<b>MODE 2</b> Elevator /Aileron Stick	Push the stick forward or backward and the quadcopter will fly forward or backward; Push the stick left or right and the quadcopter will fly left or right.
3	Aileron Trim	Aileron trim adjusts for left and right drift.
4	Elevator Trim	Elevator trim adjusts for forward and backward drift.
5	Rudder Trim	Rudder trim adjusts for drift of left and right rotation or yaw.
6	Throttle Trim	Throttle trim is normally left at neutral.
7	Power Switch	Push to turn on the transmitter. Push again to turn off.
8	Video	Press video button to start recording and press again to stop.

## 8.2 INSTALL THE TX BATTERY

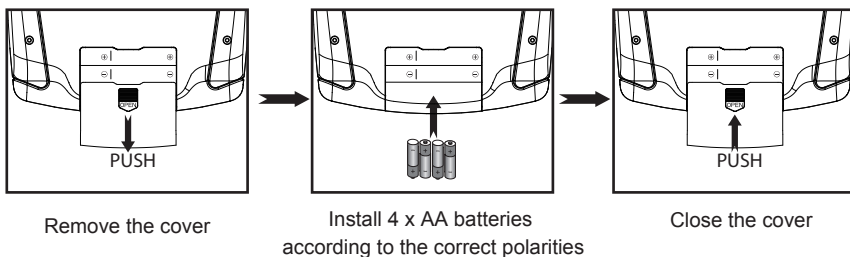

- Do not mix old and new batteries
- Do not mix different types of batteries
- Do not charge non-rechargeable battery.

## Notice:

1. When the power on the transmitter runs low, the red LED will blink quickly and the LCD screen will turn black, also the transmitter and Q4 may disconnect. Please replace with new batteries.
2. If the batteries in the transmitter runs low while flying the Q4, you can still control the Q4, please land the Q4 and then replace batteries.
3. The Transmitter can only use 2S Lipo batteries, 4XAA batteries or NI-MH AA batteries, other batteries will damage the Transmitter.

## 8.3 VIDEO REPLAY SETUP

If you would like to replay the previous videos on transmitter, then follow the instructions below.

Pull the throttle stick to the lowest position and long press the Pitch stick simultaneously to enter into MAIN MENU interface. Push the Elevator stick up/down to select "Play Record". Select "Exit" to exit.

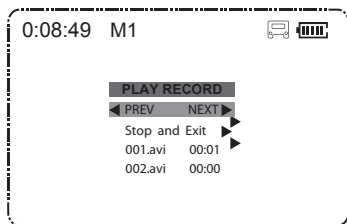
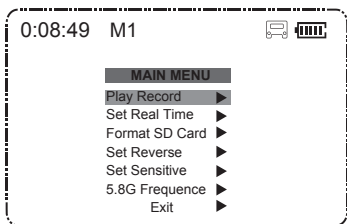

## 8.4 TIME SETUP

Pull the throttle stick to the lowest position and long press the Pitch stick simultaneously to enter into MAIN MENU interface. Push the Elevator stick up/down to select "Set Real Time". Select "Exit" to exit.

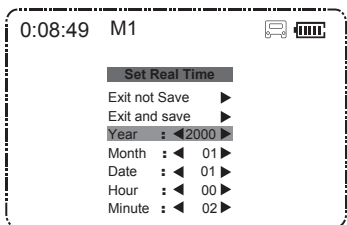
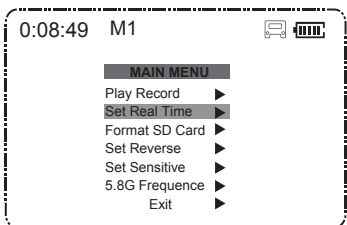

## 8.5 FORMAT SD CARD SETUP

Pull the throttle stick to the lowest position and long press the Pitch stick simultaneously to enter into MAIN MENU interface. Push the Elevator stick up/down to select "Format SD CARD".

Select "Exit" to exit.

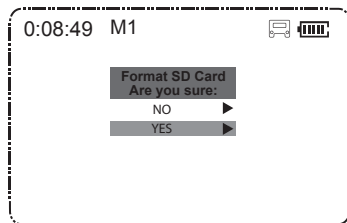
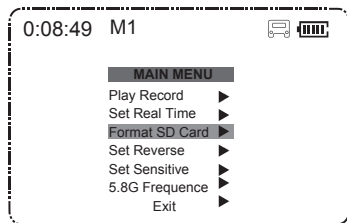



## 8.6 REVERSING CHANNEL SETUP

If you would like to reverse any of the stick functions due to personal preference then follow the instructions below. Be aware that it will change the controls back to front.

Pull the throttle stick to the lowest position and long press the Pitch stick simultaneously to enter into MAIN MENU interface. Push the Elevator stick up/down to select "Set Reverse". Select "Exit" to exit.

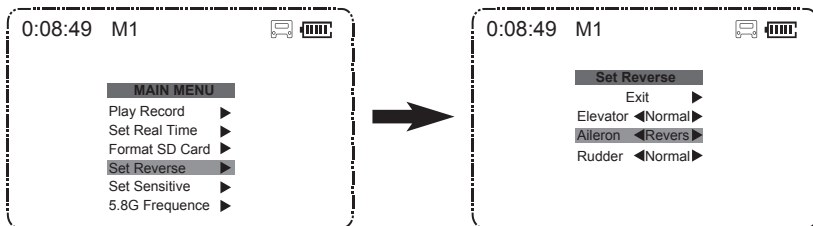

## 8.7 SENSITIVITY SETUP

If you would like to change the sensitivity of any of the stick functions then follow the instructions below.

Pull the throttle stick to the lowest position and long press the Elevator stick to enter into the MAIN MENU interface. Push the Elevator stick up/down to select "Set Sensitive", push the tick right to enter into the "Set Sensitive" interface, select "Expert mode" or "Normal mode". Select "Exit" to exit.

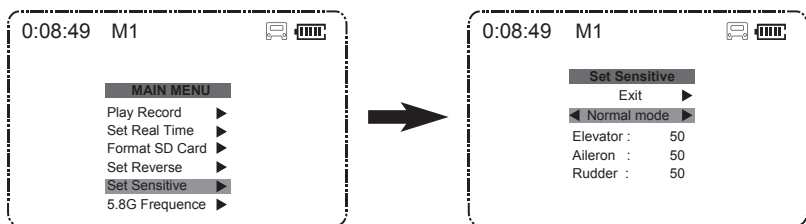

Sensitivity default setting is in Normal Mode.

## 8.8 FREQUENCY SELECTABLE 5.8GHZ

The transmitter will automatically find the best frequency to ensure a live video with good quality of transmission. Please re-select the frequency from 5730MHZ to 5845MHZ to get a better video transmission when necessary.

Pull the throttle stick to the lowest position and press the Elevator stick for 1.5 second to enter into the MAIN MENU interface. Push the Elevator stick up/down to select "5.8G Frequency", push the stick to the right to enter into the "5.8G frequency" interface, select a matched frequency.

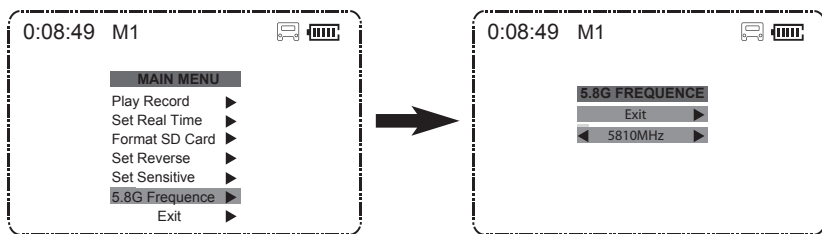

## 9.CALIBRATION

**Mode 2:** Push the Throttle Stick to the right lowest corner, and move the Aileron Stick left to right quickly, the 4 LED indicators will blink alternately, and the calibration is completed when the indicators stop blinking.

**Mode 1:** Push the Throttle Stick to the right lowest corner, put the Aileron Stick to the lowest and move it left to right quickly, the 4 LED indicators will blink alternately, and the calibration is completed when the indicators stop blinking.

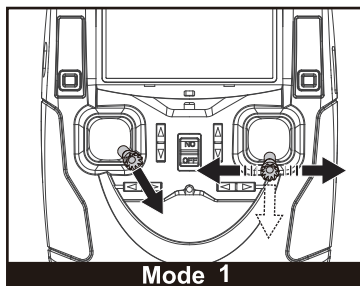
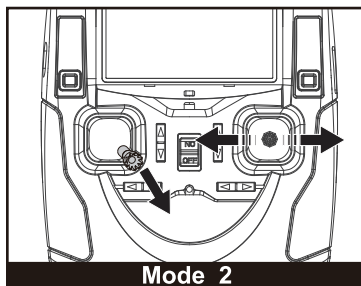

## EXPLODED VIEW

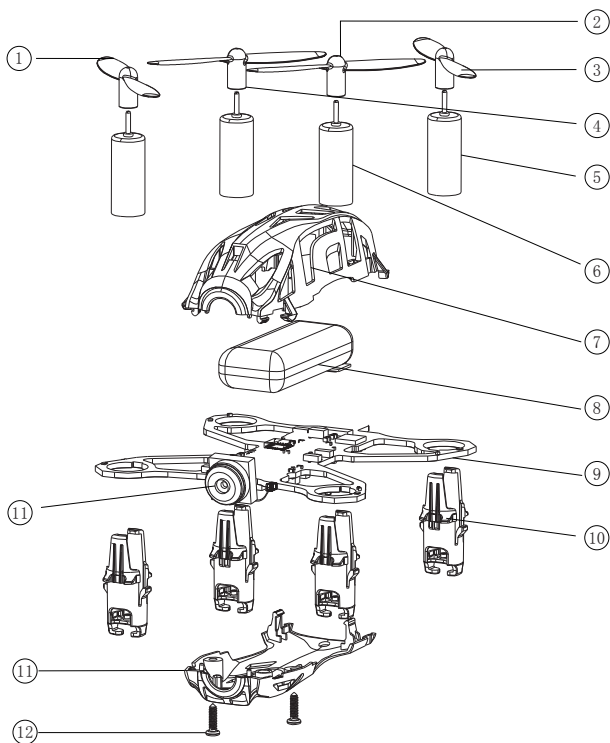

NO	PART NAME	QTY
01	Propeller A	2
02	Propeller B	2
03	Propeller A	2
04	Propeller B	2
05	Motor A	2
06	Motor B	2
07	Upper Body Shell	1

NO	PART NAME	QTY
08	Li-Po Battery	1
09	PCBA	1
10	Motor Holder	4
11	Camera Module	1
12	Lower Body Shell	1
13	Screw	2

---

## H111D TROUBLESHOOTING

### ***1. Transmitter and Q4 do not pair.***

Power on the Q4 after the transmitter shows “Bind to Plane”. Close the Transmitter to the Q4 during binding. Make sure you do not move the transmitter sticks or trim during initial power-on.

### ***2. Transmitter LED suddenly goes out.***

Replace the AA batteries in the transmitter.

### ***3. Transmitter display is not showing the setting interface after holding down the Elevator stick for 2 seconds.***

The throttle stick needs to be in the fully down position.

### ***4. Gyro is not working well.***

- (1) Battery voltage is too low.
- (2) Pair the Q4 with the transmitter again.
- (3) Land the Q4 with the throttle stick in the fully down position for 3 seconds and then take off again.

### ***5. Q4 won't perform flips.***

- (1) Press and hold down the throttle stick for 1 seconds to enter into flip mode. Do the flip when the transmitter “beeps”.
- (2) LiPo power is too low. Recharge the Q4.

### ***6. Quadcopter is shaking and making noise.***

Check that the motors, canopy, body and propellers are all properly positioned.

### ***7. Cannot take off.***

- (1) Make sure the propellers are installed correctly. The propellers are marked with "A" (clockwise) and "B" (counterclockwise). Refer to the Top View picture below for the correct orientation.
- (2) Make sure that each motor is installed correctly. There are two different motors with different motor wire colors. Refer to the Bottom View picture below for the correct order.

## FCC INFORMATION

This equipment has been tested and found to comply with the limits for a Class B digital device, pursuant to Part 15 of the FCC Rules. These limits are designed to provide reasonable protection against harmful interference in a residential installation. This equipment generates, uses, and can radiate radio frequency energy and, if not installed and used in accordance with the instructions, may cause harmful interference to radio communications. However, there is no guarantee that interference will not occur in a particular installation. If this equipment does cause harmful interference to radio or television reception, which can be determined by turning the equipment off and on, the user is encouraged to try to correct the interference by one or more of the following measures:

- Reorient or relocate the receiving antenna.
- Increase the separation between the equipment and receiver.
- Connect the equipment into an outlet on a circuit different from that to which the receiver is connected.
- Consult the local dealer or an experienced radio/TV technician for help.

Changes or modifications not expressly approved by the party responsible for compliance could void the user's authority to operate the equipment.

This device complies with Part 15 of the FCC Rules. Operation is subject to the following two conditions: (1) this device may not cause harmful interference, and (2) this device must accept any interference received, including interference that may cause undesired operation.

### Electrical and electronic equipment that are supplied with batteries (including internal batteries)

#### WEEE Directive & Product Disposal

At the end of its serviceable life, this product should not be treated as household or general waste. It should be handed over to the applicable collection point for the recycling of electrical and electronic equipment, or returned to the supplier for disposal.

Internal / Supplied Batteries.

This symbol on the battery indicates that the battery is to be collected separately.

This battery is designed for separate collection at an appropriate collection point.



User manual is subject to change without prior notice due to unforeseen product upgrades.

Download the latest user manual from

[WWW.HUBSAN.COM](http://WWW.HUBSAN.COM)

VERSION 1.0 EN



## H111D SPARE PART CHART



**H111D-01**  
Body Shell Set



**H111C-02**  
Motor Holders



**H111D-02**  
Propeller Set



**H111C-04**  
Motor Set



**H111C-05**  
Lipo Battery



**H111D-04**  
2.4G & 5.8G 2 in1 PCBA



**H111C-07**  
Screw Set



**H111D-03**  
Camera module



**H111C-10**  
USB Charger



**H107D-A05**  
Transmitter